

Table of Contents**1. Safety information**

- 1.1 Preparation..... 1
- 1.2 Symbols..... 2
- 1.3 Maintenance..... 2

2. Description 3

- 2.1 Components 3
- 2.2 The description of rotary switch..... 4
- 2.3 LCD monitor 4

3. Specification..... 5

- 3.1 Overview 5
- 3.2 Technical parameters..... 6-8

4. Operational guidelines 9

- 4.1 Reading hold 9
- 4.2 Backlight..... 9
- 4.3 Auto shutdown 9
- 4.4 AC current measurement 10
- 4.5 DC voltage measurement 10
- 4.6 AC voltage measurement 11
- 4.7 Low resistance measurement 11
- 4.8 Electric resistance/buzzer measurement..... 12
- 4.9 Capacitance measurement 12
- 4.10 Capacitance measurement..... 13

5. Maintenance 13

- 5.1 Battery replacement 13
- 5.2 Battery polarities cannot be reversed. 14

6. Accessories 14

1. Safety information

Warnings



Please operate this instrument with great care. Improper operation may result in an electric shock or damage to the instrument. Throughout the operation, you should follow the generally accepted safety procedures and take the safety measures as required by the Operation.

Please read carefully this Manual and take the operational methods as specified herein so as to make full use of the instrument's functionalities and ensure safe operation.





This instrument is in strict compliance with the safety requirements as specified in IEC-61010-1, IEC-61010-2-030 and IEC-61010-2-032 for electrical measuring instruments. Its pollution reaches the level of Class II and over-voltage standard is CAT III 600V.

Please strictly follow the guideline for safe operation so as to ensure safety while operating this instrument.

1.1 Preparation

- ⇒ The user must observe the standard safety rules when operating this instrument:
 - General protection against electrical shock
 - Prevention of unintended use
- ⇒ Upon the arrival of the instrument, check any damage that arises during transportation.
- ⇒ Upon the arrival of the instrument that has been stored and shipped in rough conditions, check and identify any damage.
- ⇒ The instrument must be kept in a good condition. Prior to its use, check the possible damage to insulation part and potential exposed metal wire of the lead.

1.2 Symbols

	Note (For important safety information, see Operation Manual)
	This symbol indicates that it can be used on a hazardous live conductor.
	Double insulation protection (Category II)
CAT III	refers to over-voltage level III (installation) as specified in IEC-61010-1standard. Pollution level 2 refers to the level of impulse withstand voltage protection.
	It is compliant with appropriate EU standard.
	Grounding

1.3 Maintenance

- ⇒ Do not attempt to open the bottom case to adjust or repair instruments. Such operation can only be executed by an electrician who is fully familiar with the instrument and electric shock risks.
- ⇒ Remove pen-shaped meter from the line to be measured, before opening the instrument's bottom case or battery cover
- ⇒ To avoid an electric shock that results from any false readings, replace existing battery when the symbol  is displayed.
- ⇒ Don't use any abrasive agents or solvents when a wet cloth and mild detergent are being employed to clean the instrument.
- ⇒ Power off and keep the range switch to the position "OFF" when the instrument is not in use.
- ⇒ Remove battery to avoid any damage to the instrument when the instrument is not in use for a long period.

2. Description

2.1 Components

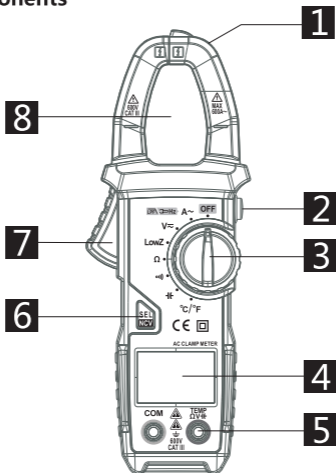

- 1 Non-contact voltage detection
- 2 Data hold/Backlight key
- 3 Rotary switch
- 4 Display screen
- 5 Input socket
- 6 Function Selecting/non-contact voltage detection key
- 7 Trigger
- 8 Current clamp head: for current measurement

2.2 The description of rotary switch

- OFF:** Shutdown position
A~ AC current measurement
V \approx AC/DC voltage measurement
Low Z Low resistance voltage measurement
 Ω Electric resistance measurement
 $\cdot \text{||}$) ON/OFF measurement
 $\text{||} \text{---}$ Capacitance measurement
 $^{\circ}\text{C}/^{\circ}\text{F}$ Temperature measurement

2.3 LCD monitor

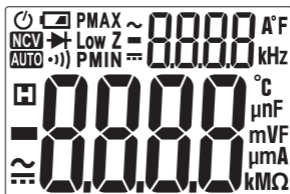

\sim 	AC & DC
$\cdot \text{ }$)	On/Off indication
AUTO	Automatic range measurement mode
⏻	Auto shutdown indication
⏻	LOW BATTERY
H	Hold status
V,A	Volt (Voltage);Ampere (Current)

Ω ; k Ω ; M Ω	Ohm, kilohm and megohm (Resistance)
Hz, kHz,	Hz, kHz
NCV	Non-contact voltage detection
μ F	μ F
$^{\circ}$ C $^{\circ}$ F	$^{\circ}$ C $^{\circ}$ F
LowZ	Low resistance measurement mode

3. Specification

The instrument shall be re-calibrated at an interval of one year under the conditions of 18 $^{\circ}$ C-28 $^{\circ}$ C and relative humidity of less than 75%.

3.1 Overview

- The instrument is designed to automatically select measurement functions and measuring ranges.
- Full range overload protection.
Allowable max voltage between terminal to be measured and ground:600V DC or 600V AC
- Working weight: max2000m
- Display unit: LCD
- Max display value:6000 numbers
- Polarity indication: automatic indication. '-' indicates negative polarity.
- Over range indication: '0L' or '-0L'
- Sampling rate: approximately 3 times per second
- Unit display: to display functions and electric quantity
- Automatic shut-down time:10 minutes
- Power supply: 1.5V AAA battery \times 2
- Battery under-voltage indication: LCD display the symbol .

- Temperature coefficient: less than 0.1x accuracy/°C
- Working temperature: 18°C ~ 28°C
Storage temperature: -10°C ~ 50°C

3.2 Technical parameters

3.2 Technical parameters

3.2.1 AC current

Measuring range	Resolution	Accuracy
6A	0.001A	± (2.5% Reading + 8digits)
60A	0.01A	
400A	0.1A	
400A~600A	0.1A	± (3% reading + 10 digits)

- Minimum input current: 0.01A AC current
- Max input current: 600A AC current
- Frequency range: 45 ~ 65Hz ;
- At the moment of AC current measurement, the instrument will automatically enable the internal low pass filter and filter out high frequency current,

3.2.2 DC voltage

Measuring range	Resolution	Accuracy
6V	0.001V	± (0.5% Reading + 3 digits)
60V	0.01V	
600V	0.1V	

- Minimal input current 0.001V DC
- Maximal input current: 600V DC

3.2.3 AC voltage

Measuring range	Resolution	Accuracy
6V	0.001V	± (0.8% Reading + 5 digits)
60V	0.01V	
600V	0.1V	

- Minimal input current:0.001V AC
- Maximal input current:600V AC (valid value)
- Frequency range:45 ~ 65Hz

3.2.4 Frequency

3.2.4.1 Frequency measurement for the current through clamp head:

Measuring range	Resolution	Accuracy
60.0Hz	0.1Hz	± (1.0% reading + 5digits)
1000Hz	1Hz	

- Measurement range:40Hz ~ 1000Hz
- Input signal range:≥ 0.2A AC current (valid value)

3.2.4.2 Frequency measurement for the current (V level)through clamp head:

Measuring range	Resolution	Accuracy
60.0Hz	0.1Hz	± (1.0% reading + 5digits)
1000Hz	1Hz	

- Measurement range:40Hz ~ 1000Hz
- Input signal range:≥ 0.2V AC voltage (valid value)

3.2.5 Electric resistance

Measuring range	Resolution	Accuracy
6k Ω	0.001k Ω	\pm (0.8% Reading + 3 digits)
60k Ω	0.01k Ω	
600k Ω	0.1k Ω	
6M Ω	0.001M Ω	
60M Ω	0.01M Ω	

- Overload protection:250V DC or AC (valid value)

3.2.6 Line On/Off test

Measuring range	Resolution	Functions
•))	1 Ω	If the electric resistance of the line measured is less than 50 Ω ,the buzzer inside the instrument may sound.

- Overload protection:250V DC or AC (valid value)

3.2.7 Capacitance

Measuring range	Resolution	Accuracy
600 μ F	0.1 μ F	\pm (4% Reading + 3 digits)
6000 μ F	1 μ F	

- Overload protection:250V DC or AC (valid value)



3.2.8 Temperature

Measuring range	Resolution	Accuracy
-20~1000 $^{\circ}$ C (-4~1832 $^{\circ}$ F)	1 $^{\circ}$ C/2 $^{\circ}$ F	\pm (1% Reading + 2 digits)



- Overload protection:250V DC or AC (valid value)

4. Operational guidelines

4.1 Reading hold

During the process of measurement, gently touch the key /☀ if you want to hold readings, and monitor's display value will be locked. Touch again the key /☀, the readings hold will be removed.

4.2 Backlight

- 1) In the process of measurement, if the measurement environment is too dark, press the key /☀ for more than 2 seconds to enable backlight function. Then about 1 minute later, the backlight function will be automatically disabled.
- 2) During this process, press the key /☀ for 2 seconds to disable backlight.

4.3 Auto shutdown

- 1) If no operations occur within 10 minutes after the initialization, the instrument will be in the state of dormancy. Auto shutdown at this moment can save power consumption. 2 minutes before shutdown, the buzzer will sound at an interval of 1 minute.
- 2) Press any key after Auto shutdown to wake the instrument into operation.
- 3) The function of Auto shutdown will be disabled if SEL/NCV key is pressed while the instrument is initialized.

4.4 AC current measurement

Turn the rotary switch to switch to the AC measuring range, hold the trigger, open clamp head, put a lead wire of the line to be measured into the clamp. Then the primary display panel will display the measured current value while the secondary display panel will show the measured frequency value.

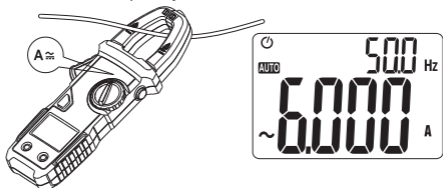

4.5 DC voltage measurement

Turn the selector switch to AC/DC voltage position, press SEL key to switch to DC voltage measurement mode, and connect the pen-shaped meter to the signal to be measured. The red meter is connected to the positive pole of the signal to be measured and the black meter to its negative pole.

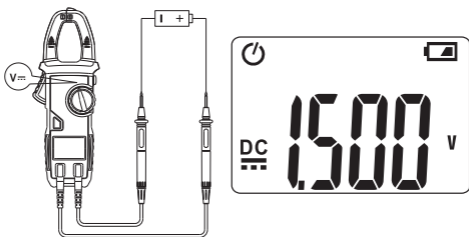

4.6 AC voltage measurement

1) Turn the selector switch to AC/DC voltage position and press SEL key to switch to AC voltage measurement mode, connect the pen-shaped meter to the signal to be measured. Then the primary display panel shows the measured voltage value and the secondary display panel the measured frequency value of voltage.

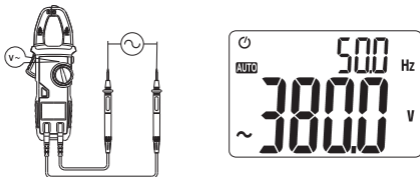

4.7 Low resistance measurement

Turn the selector switch to LowZ position and connect the pen-shaped meter to the signal to be measured. The primary display panel shows the measured voltage value. The instrument will automatically recognize whether the measured signal is DC voltage or AC voltage.

Note: In the low resistance measurement mode, the longest duration for measurement shall not exceed 1 minute.

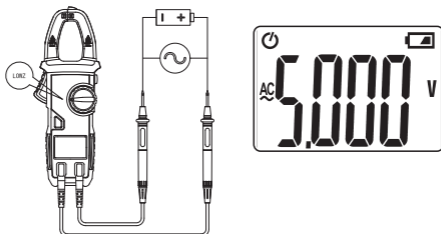

4.8 Electric resistance/buzzer measurement

Connect the pen-shaped meter to the grounding resistance to be measured. The instrument will display the measured resistance value. When the measured resistance is less than 50Ω and the rotary switch is switched to buzzer position, the instrument's buzzer will sound alarms.

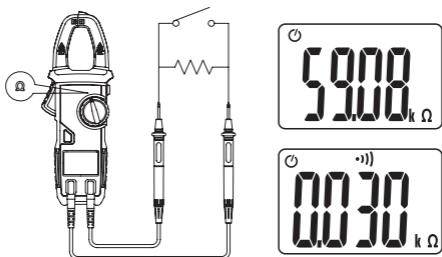

4.9 Capacitance measurement

Turn the selector switch to capacitance position and connect the pen-shaped meter to the signal to be measured. The primary display panel will display the measured capacitance.

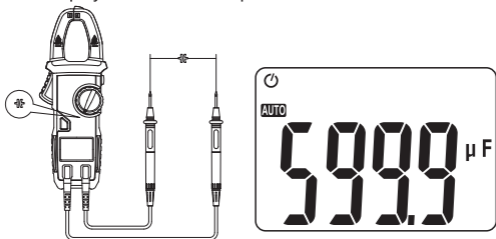

4.10 Temperature measurement

1) Turn the selector switch to °C/°F position, insert thermocouple probe into input socket, with the positive pole of the probe being connected to red input terminal. The primary display panel will show the measured temperature marked in °C and secondary display panel the measured temperature marked in °F.



5. Maintenance

5.1 Battery replacement

Warnings



Before the instrument's battery cover is opened, remove the pen-shaped meter from the circuit to be measured, so as to avoid the risk of an electric shock.

- ① If the symbol " " appears, it indicates that the battery should be replaced.
- ② Unscrew the fastening screw on the battery cover and remove it.
- ③ Replace the old battery.
- ④ Mount the battery cover as it is

Notes

Battery polarities cannot be reversed.

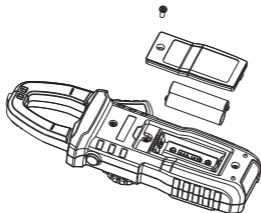

5.2 Battery polarities cannot be reversed.

Warnings



The same or equivalent pen-shaped meter must be used to replace the old pen-shaped meter. The pen-shaped meter must be intact. Its grade must be 1000V 10A.

The pen-shaped meter must be replaced if its insulating layer is damaged (e.g. the metal wire of the guide is exposed.)

6. Accessories

①	Pen-shaped meter	Level:1000V 10A	A pair
②	Operation Manual		one
③	battery	1.5V AAA battery	2
④	Cloth bag		1
⑤	Thermocouple probe		1